



Fabricant français  
depuis 1964

[www.gys.fr](http://www.gys.fr)



# POSITIONNEURS MAGNÉTIQUES

Pour plus de confort lors de vos soudures



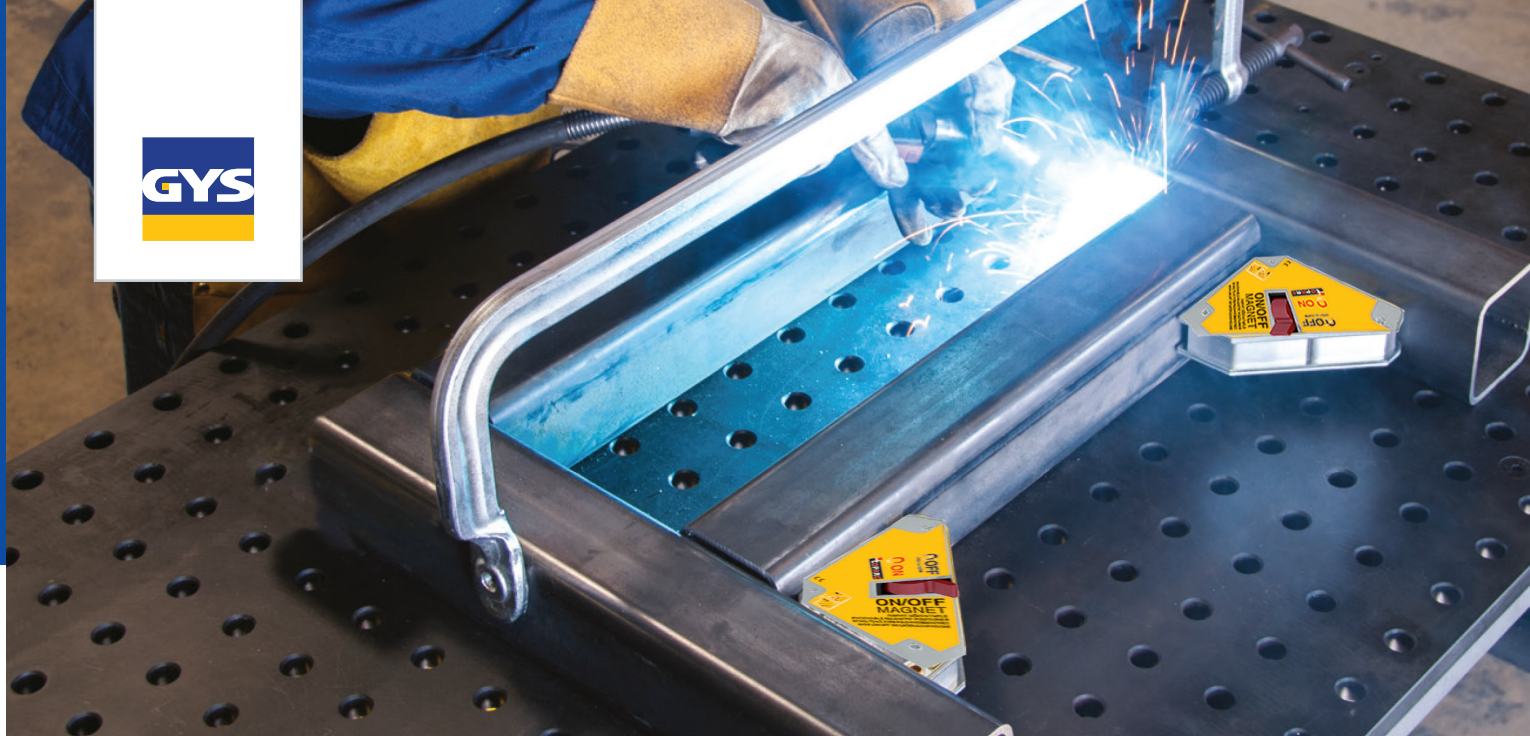

## Des positionneurs magnétiques pour le confort du soudeur

### MAGNETIC P 15.90

- Angle : 60° & 90°
- $\downarrow$  max 15 kg
- $\downarrow$  mm 100 x 73 x 12
- $\downarrow$  x2



047044

### MAGNETIC P 16.90

- Angle : 45°, 90° & 135°
- $\downarrow$  max 16 kg
- $\downarrow$  mm 45 x 32 x 28
- $\downarrow$  x4

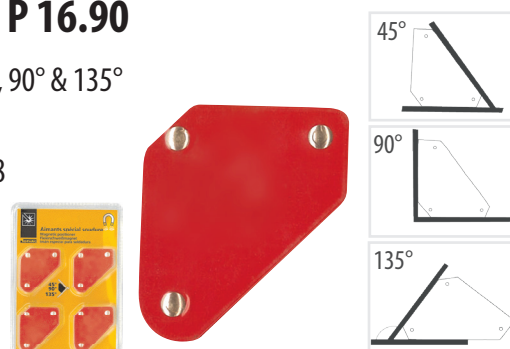

044180

### MAGNETIC P 19.90

- Angle : 45°, 90° & 135°
- $\downarrow$  max 19 kg
- $\downarrow$  mm 156 x 102 x 20
- $\downarrow$  x1

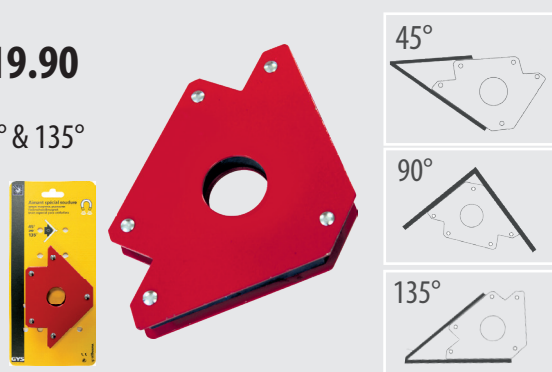

044203



### MAGNETIC P 20.180

- $\downarrow$  0 > 180°
- $\downarrow$  max 20 kg
- $\downarrow$  mm 204 x 86 x 28
- $\downarrow$  x1



044302

### MAGNETIC D50.90 DUAL Switchable

- Angle : 90°
- $\downarrow$  max 50 kg
- $\downarrow$  mm 148 x 148 x 38
- $\downarrow$  x1



047051

## MAGNETIC D36.90

Switchable

- Angle : 45°, 90° & 135°
- $\overset{\text{max}}{\updownarrow}$  30 kg
- $\updownarrow$  111 x 95 x 25 mm
- $\times 1$

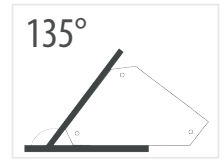
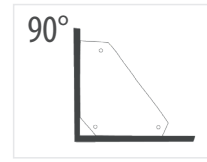
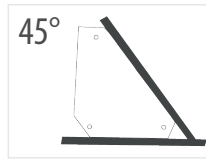

044197

## MAGNETIC D50.90

Switchable

- Angle : 90°
- $\overset{\text{max}}{\updownarrow}$  50 kg
- $\updownarrow$  71 x 60 x 48 mm
- $\times 1$



047075

## MAGNETIC D70.90 M

Switchable

- Angle : 90°
- $\overset{\text{max}}{\updownarrow}$  70 kg
- $\updownarrow$  48 x 32 x 70 mm
- $\times 1$



047068

## MAGNETIC D70.120M

Switchable

- Angle : 45°, 60°, 75°, 90°, 105° & 135°
- $\overset{\text{max}}{\updownarrow}$  70 kg
- $\updownarrow$  111 x 55 x 80 mm
- $\times 1$

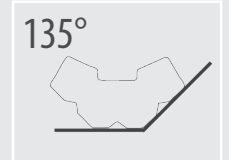
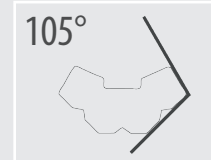
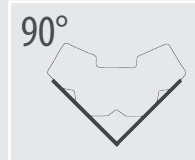
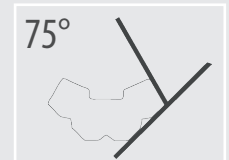
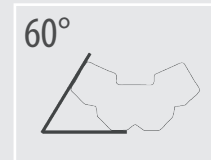
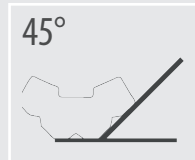

047082

## MAGNETIC D70.135M

Switchable

- Angle : 45°, 75°, 90°, 105° & 135°
- $\overset{\text{max}}{\updownarrow}$  70 kg
- $\updownarrow$  99 x 55 x 80 mm
- $\times 1$

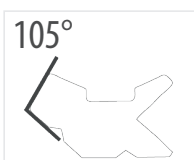
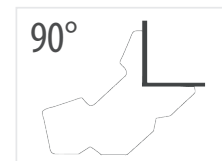
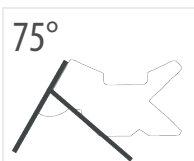
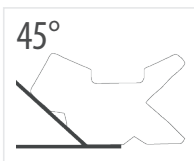

047099





Créé en 1964, GYS est un groupe familial français regroupant 700 collaborateurs dans le monde. Fort d'un centre de recherche de premier plan, GYS est un acteur majeur dans la conception et la fabrication d'équipements de soudage, de chargeurs de batteries et de systèmes de réparation carrosserie.

 **GYS France (HQ)**  
1, rue de la Croix des Landes  
CS 54159  
53941 Saint-Berthevin - Cedex  
Laval - France  
Fax : (+33) 2 43 68 35 21  
[www.gys.fr](http://www.gys.fr) / E-mail : [contact@gys.fr](mailto:contact@gys.fr)